



# De principes van de ontwerpbibliotheek EMC&25kV

25-08-2000



- Plaats van ontwerpbibliotheek in de
- levenscyclus

*Systeem ontwikkelen op basis van project eisen*

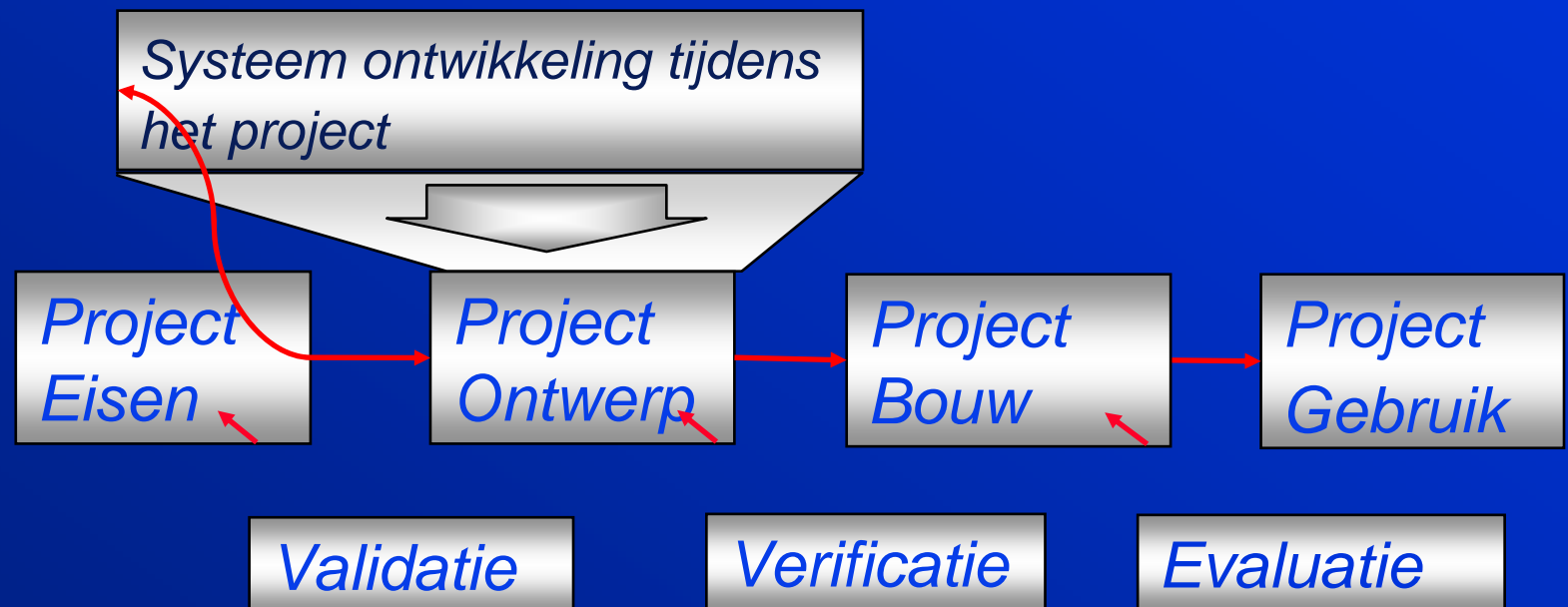

- Plaats van ontwerpbibliotheek in de
- levenscyclus

# Ontwerpbibliotheek

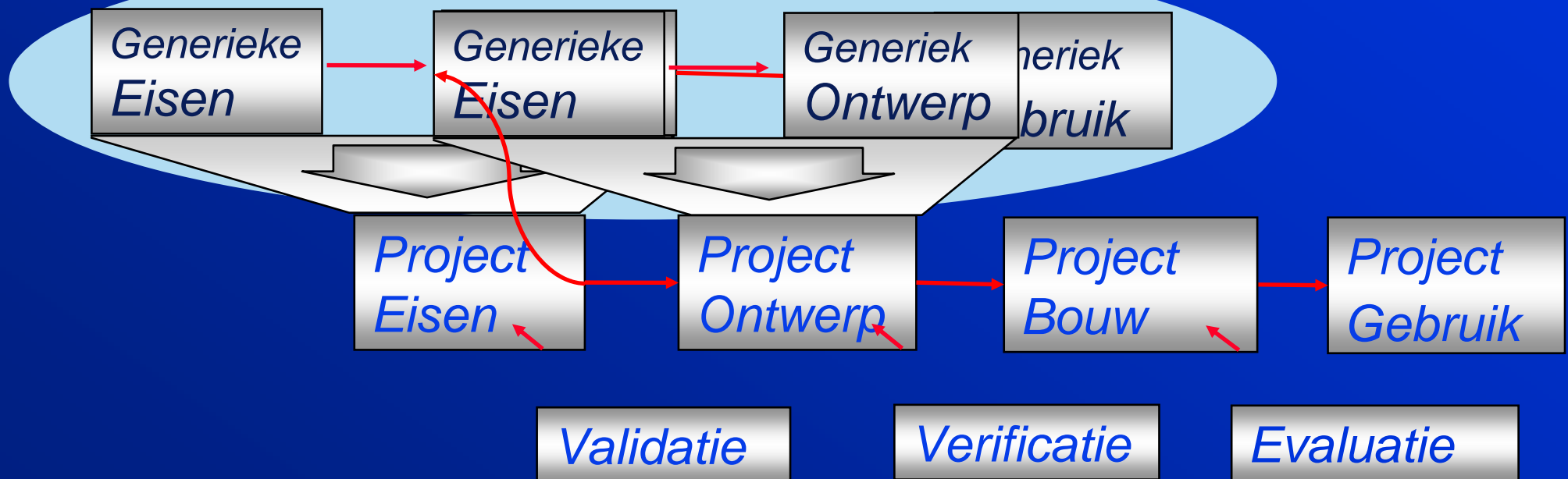

- Soorten documenten in de
- ontwerpbibliotheek

# Ontwerpbibliotheek

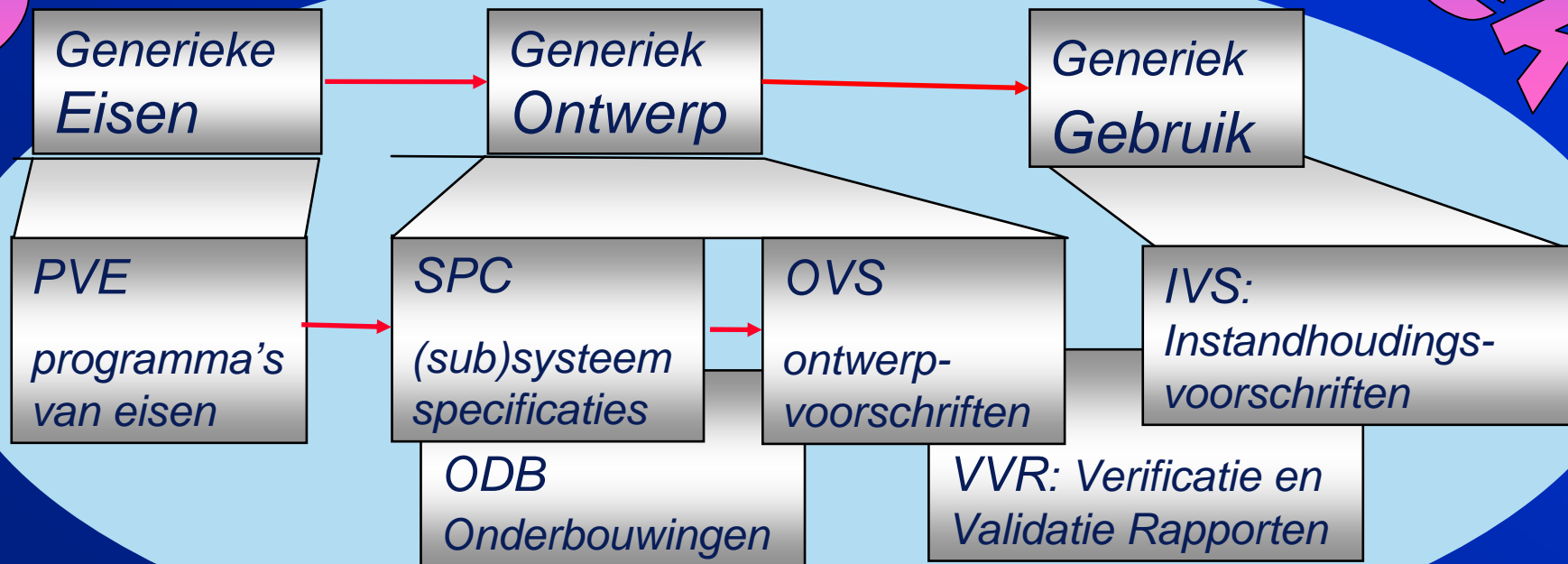





- Eisen en ontwerpspec's gelegd op de
- system breakdown

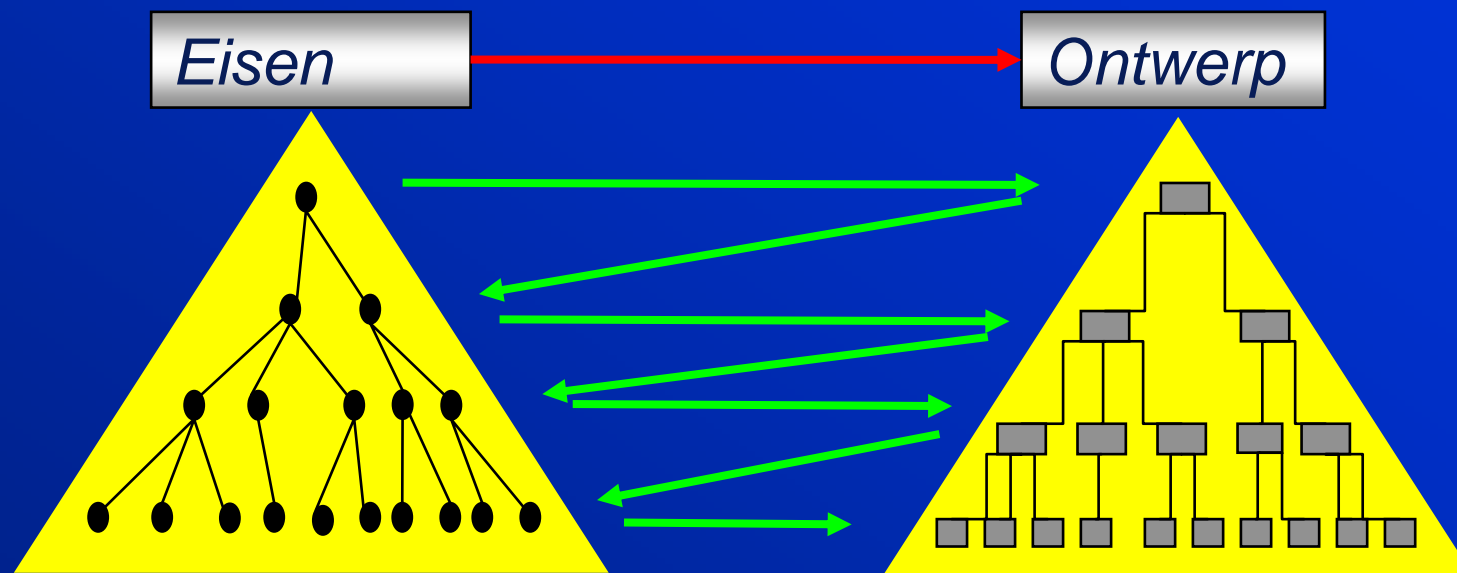

# System breakdown

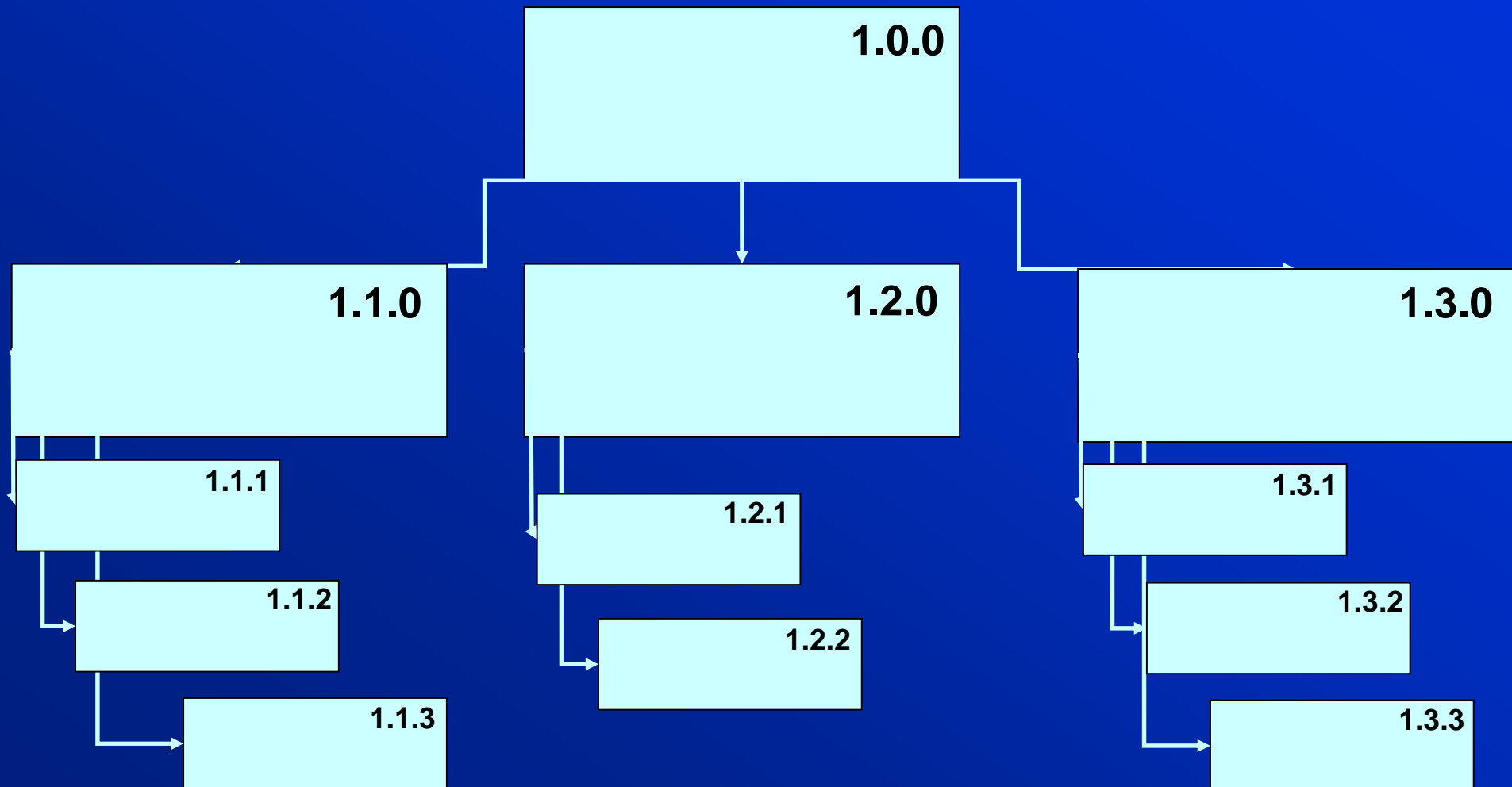

- System breakdown en
- documentstructuur

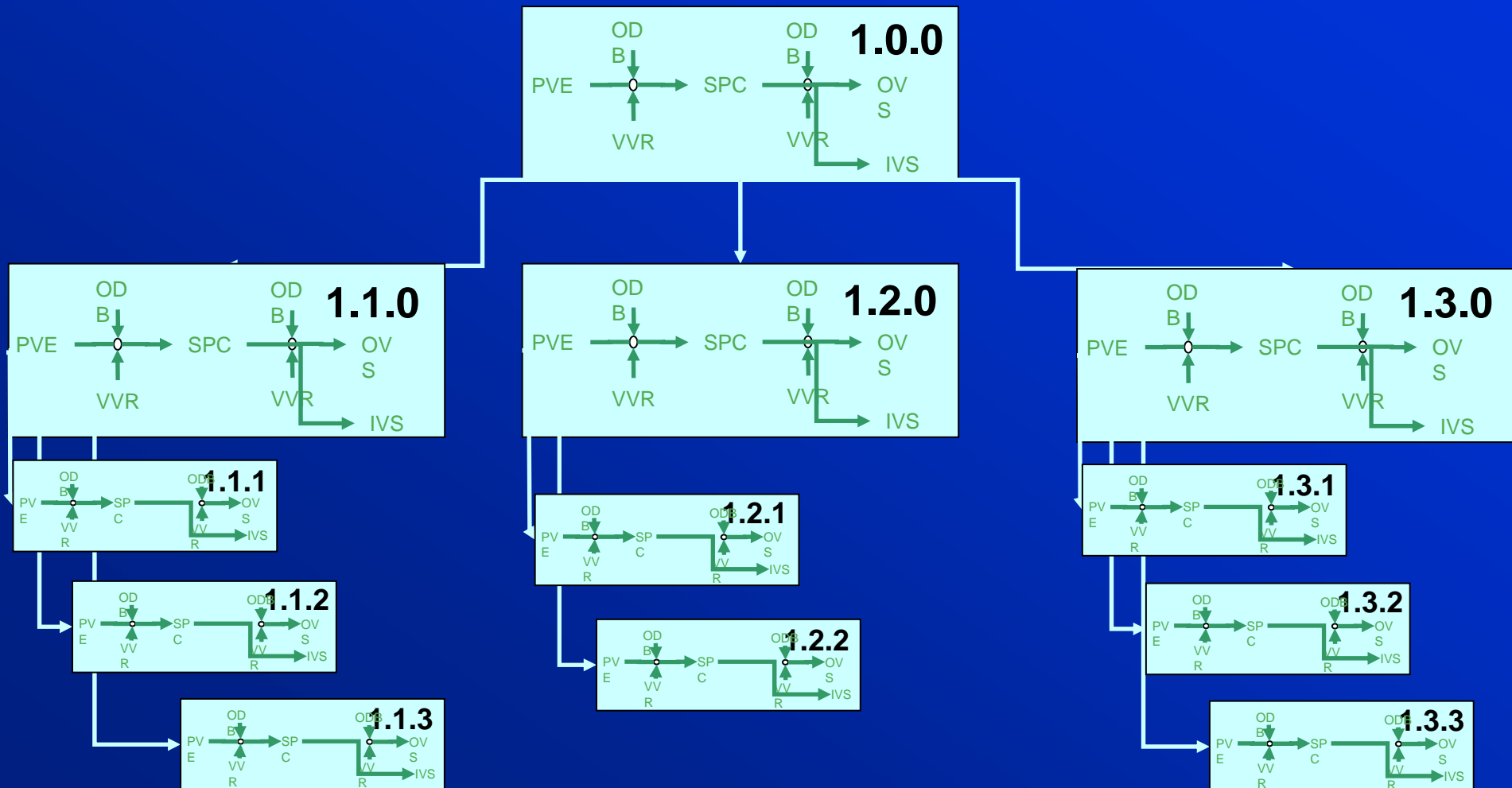

- System breakdown documentstructuur
- en relaties tussen documenten

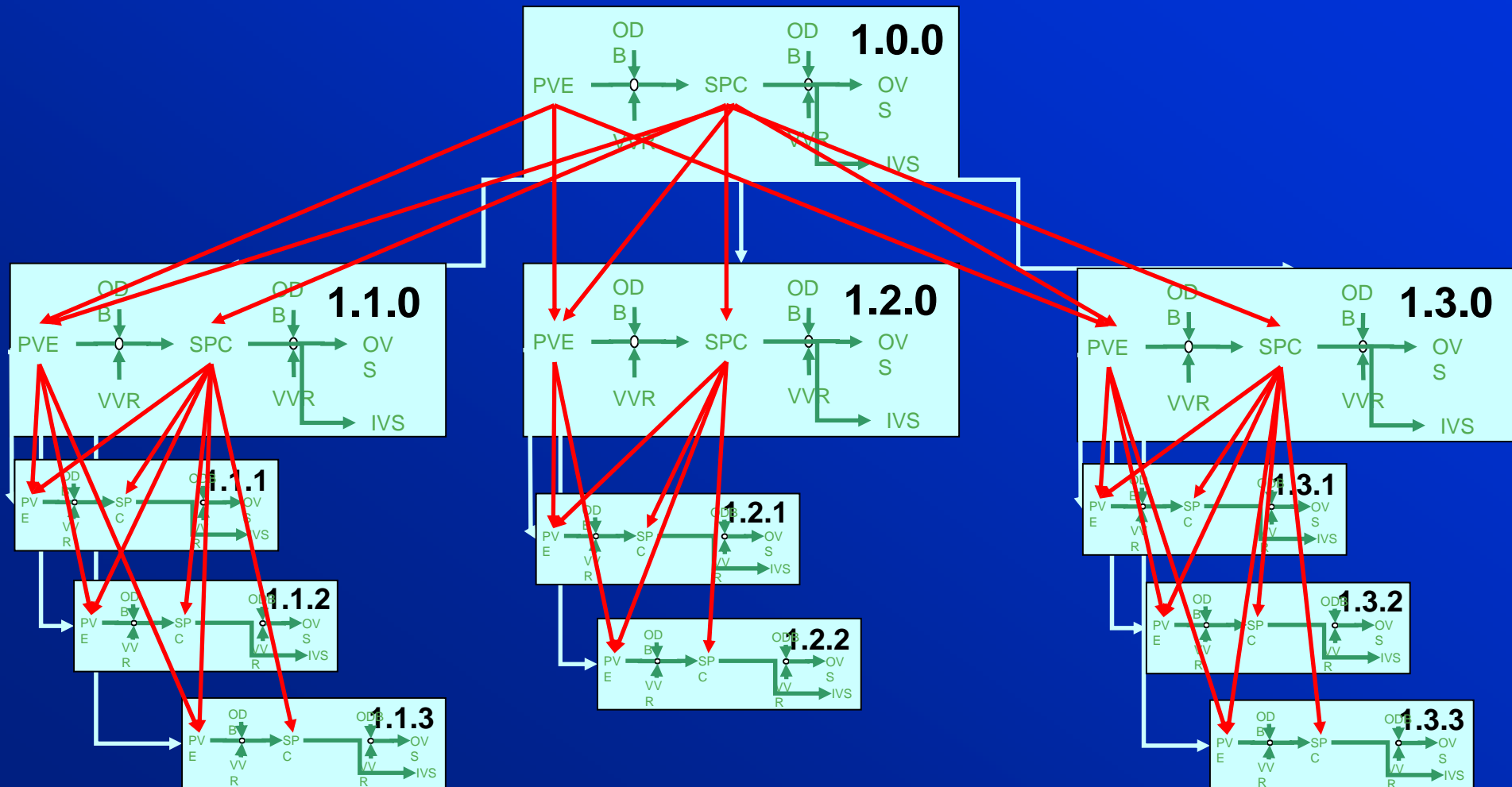



- 
- 
- 
- 
- 
- 
- 

## Demo database



- 
- **Basisprincipe**
- Het V-vormige ontwerpmodel

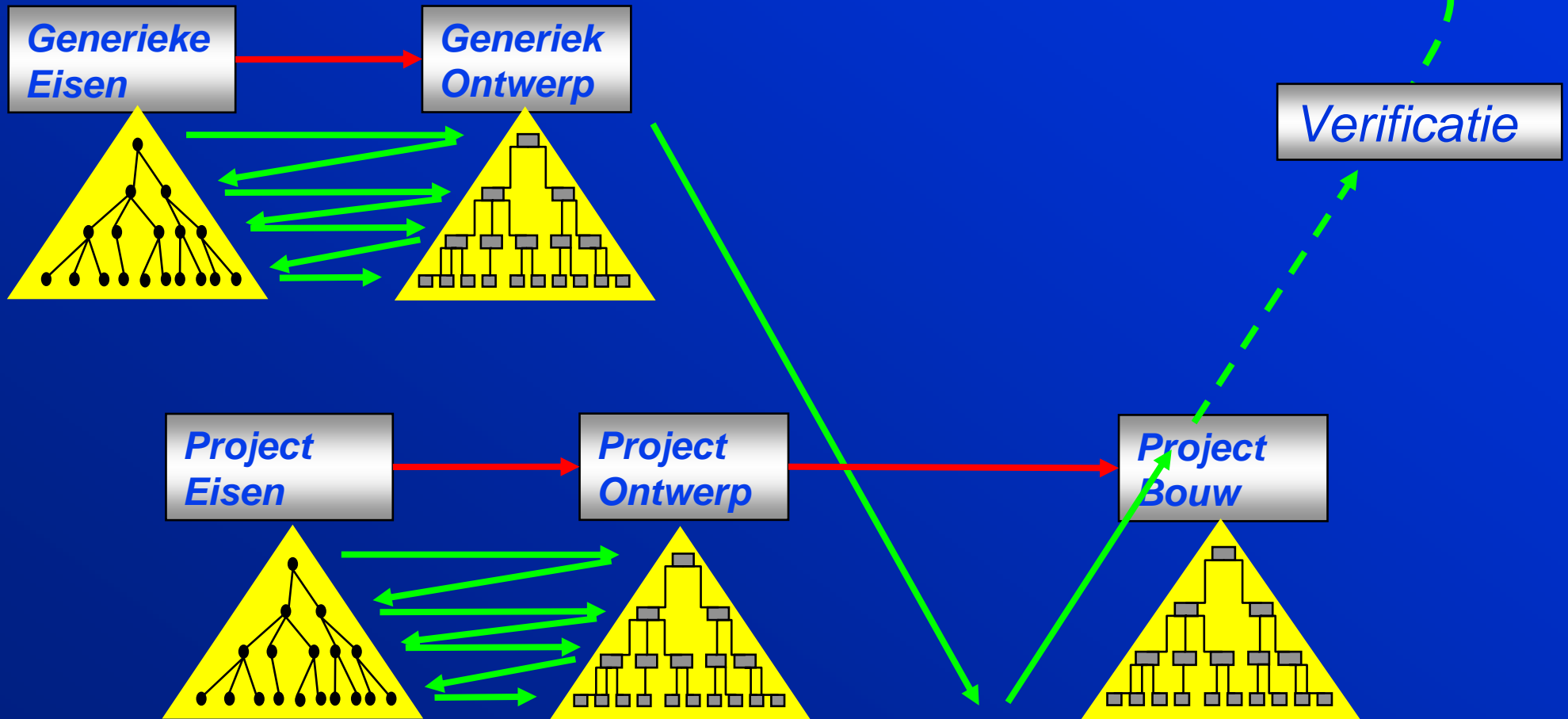

•  
•  
•  
•  
•  
•

